



Green Warrior[™]

NOVA 40 & 45 TOWER

MANUAL



Safety Information

- The Plant Tower is an aeroponic growing system. Do not stand on the system and don't allow children to play with the tower.
- Follow the safety instructions mentioned on the water pump. Do not attempt to plug or unplug the pump in rainy or damp conditions.
- While draining the Tower, do not allow the water to drain over an electrical outlet or extension cord. Do not overfill the Tower, which would allow water to run out of the electrical cord opening in the reservoir.
- Do not place the Tower where there is the potential for high winds, such as on the walls of the balconies.

Tower Management

- Check the water level weekly. During hot months, and once you have large plants, check the water level at least twice a week.
- Clean the pump filter monthly. Unplug the pump, pull the pump up through the access port and remove the cover. Clean with water to remove debris, also another technique is to turn off the pump and firmly place a garden hose at the top of the centre stem in your shower cap. This will blow old root debris out of the filter into the bottom of the tank.
- Good sunlight is essential for the optimal growth of each plant for 3-4 hours a day.

Parts

- A.** Crown
- B.** Pipe
- C.** Tower section
- D.** Tank
- E.** Screw
- F.** Pump
- I.** Bottom
- J.** Net Pot
- K.** Pipe Connector
- L.** Tank Cover

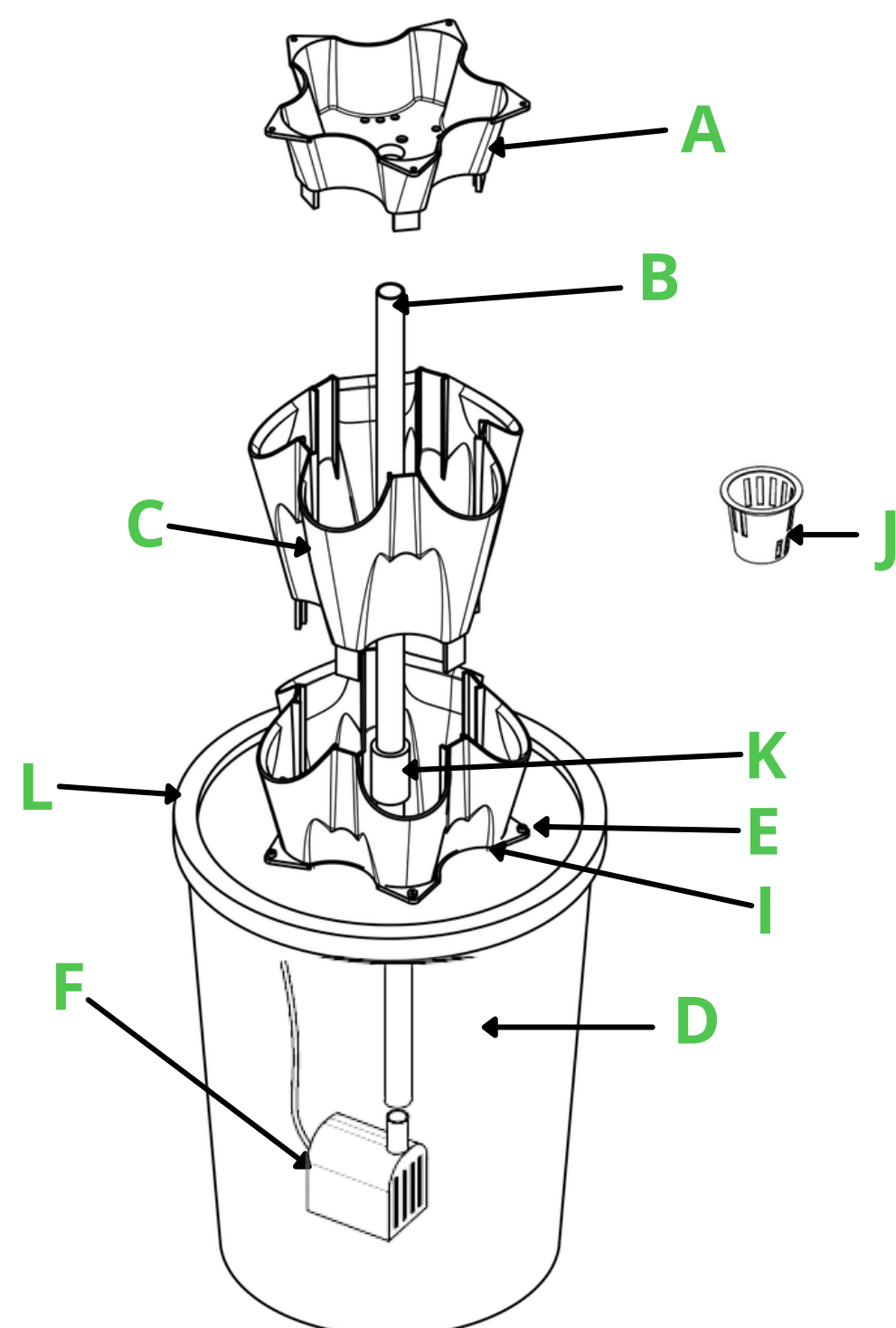

How to Assemble



Attach Base to tank cover with help of 5 screws

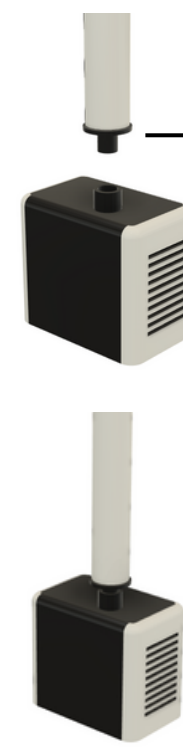
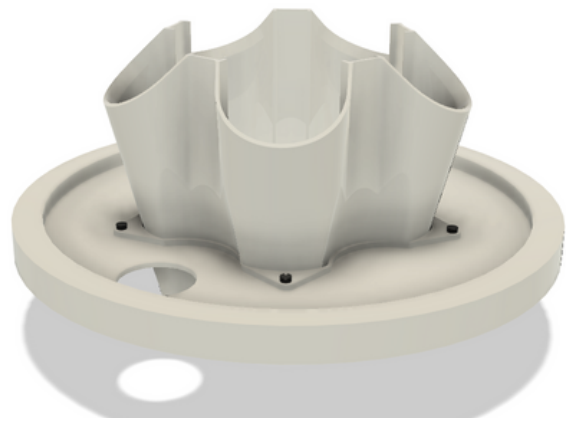
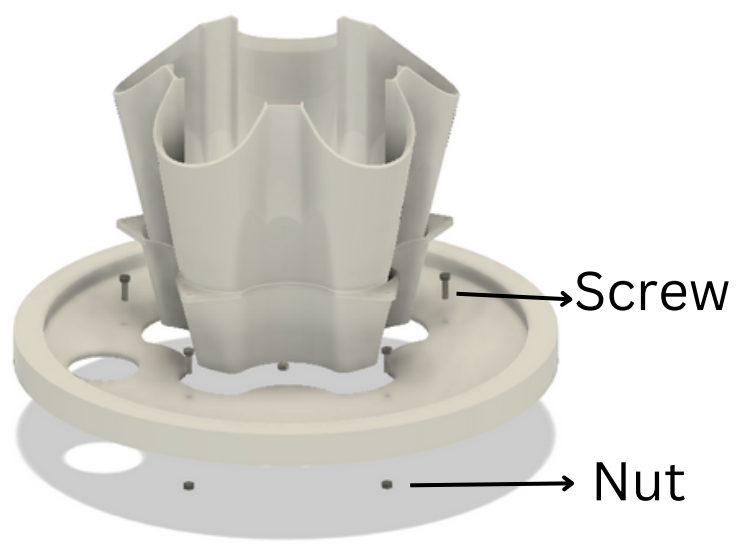

Pipe with black piece

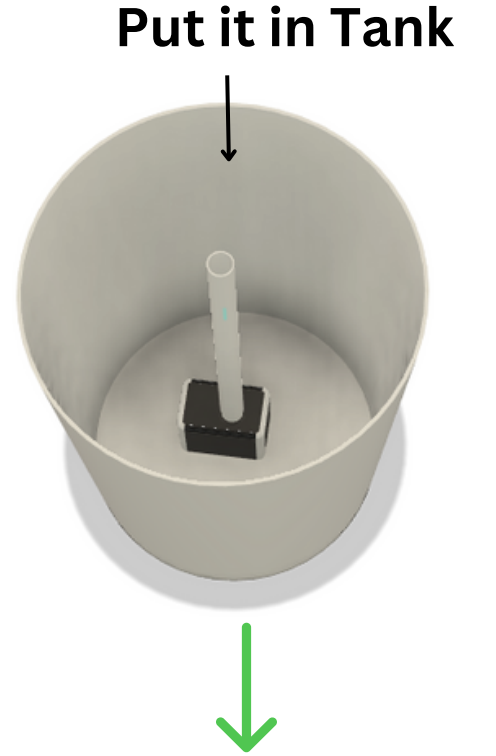

Put another section



Connect 2nd pipe with pipe joiner

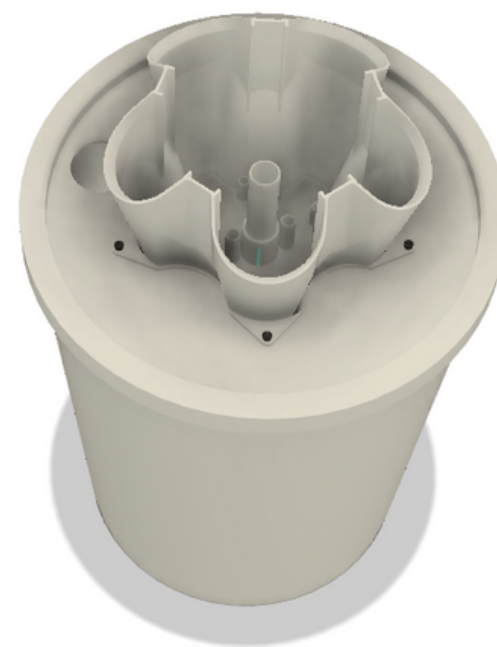

Put Tank cover and base on tank



Add Top Cover to Tank

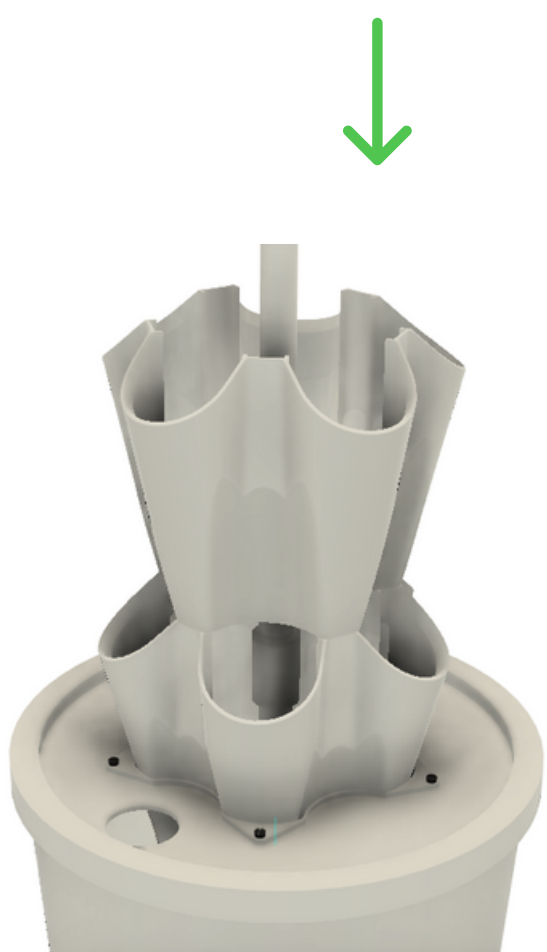

Connect another piece of pipe with pipe joiner

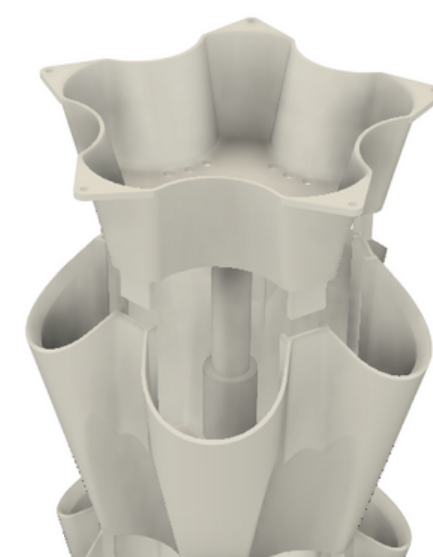
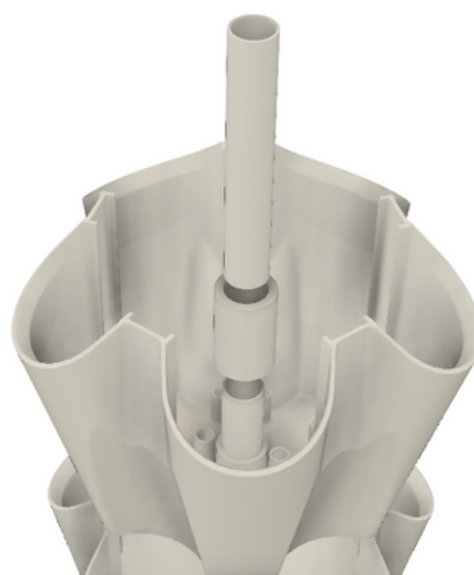

Repeat above steps, at the end add top

Watch the full Assembly Video Here - <https://youtu.be/MhXfeE-24RI>

Scan QR Code to watch -



Germination



Expand the Coco disc

- Place the Coco Disc in a waterproof tray. Make sure the small, imprinted hole is facing up. Pour warm water over the discs and wait till they get expand.

Sow the seed

- Once the Coco disc is fully expanded, place 6 seeds in every pellet. The planting depth can be controlled by pinching or compacting the pellet. Use a clear, plastic lid or plastic wrap to retain moisture. Keep it in a dark place for 3 Days.

Provide light

- After 3 days, Place the trays under grow lights or near a sunny window. Keep the pellets evenly moist while the seeds germinate. Adding a little water to the bottom of the tray once a day is usually sufficient.

Germination

- Once the seeds get germinated and the cotyledons have opened, it's best to remove the plastic cover. Continue the watering once a day to keep the pellets evenly moist.

Transplant seedlings

- When the seedlings are ready for transplant, harden off the plants. Coir pellets can be directly planted into the Tower.

Making Nutrients from Powder

- Take 2 empty Bottles of 1 Litter each, Mark each as A & B
- Mix Each packet of A & B in Bottles of A & B respectively in the water of 1 litre
- Note- Do not mix both powders in one bottle
- First, take two bottles of 1 litter each
- Then dilute each packet in each bottle separately
- This is a master solution name it a and b
- After that take One cup of each of the master solutions then mixes it up in a water bucket and wait for 10 min after that take a reading using the TDS meter, and repeat this procedure up to 300 to 400 ppm reading for the first 2 weeks after that 500 to 650 ppm for last 3 to 5 week
- Kindly check it every week

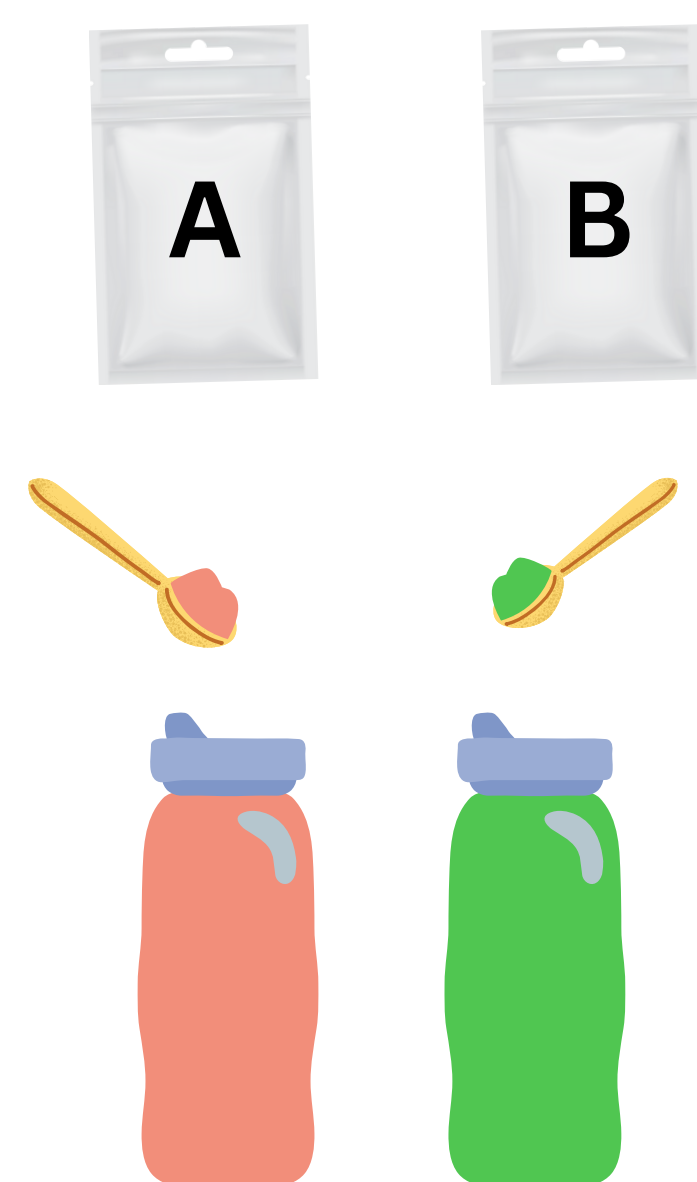

For More information Visit- www.wegreenwarriors.org